

# A Sensorless Method for Detecting Spool Position in Solenoid Actuators

Ivor Dülk

Department of Measurement and Information Systems  
Budapest University of Technology and Economics  
Magyar tudósok körútja 2. I ép., Budapest, 1117, Hungary  
divor@mit.bme.hu

Tamás Kovácsházy

Department of Measurement and Information Systems  
Budapest University of Technology and Economics  
Magyar tudósok körútja 2. I ép., Budapest, 1117, Hungary  
khazy@mit.bme.hu

**Abstract**— A method is developed to estimate the position of the moving part in a solenoid actuator. We superpose a sinusoidal component onto the base duty ratio of the drive PWM (Pulse Width Modulation), thus, a scan signal is generated which is used to first identify, then to “measure” the system during actuation. A model of the actuator device is derived from experimental analyses and the effects of e.g. scan signal frequency and supply voltage are studied. External force disturbances, which may be present in flow control applications, are also considered and an algorithm is provided for its compensation in position estimation, thus, force estimation is realized as well. The hardware requirements are low which makes the presented method suitable for cost effective embedded applications. Experimental results are also provided.

**Keywords** - magnetic valve, sensorless, external load, position

## I. INTRODUCTION

The sensorless principle employs the transducer characteristics of the actuator device during excitation, i.e. there is information encoded about some mechanical quantity in its electrical impedance, e.g. position. With the actuator being used for sensing purposes the external transducer and its accessories, such as mechanical layout and cabling, can be saved. This results in considerably reduced system cost and in improved robustness which have paramount importance in embedded systems.

Solenoids are limited travel electromechanical converters most commonly used for flow control purposes (Fig. 1), as relays or as on-off contactors. In technical literature methods for estimating the position of the solenoid’s plunger are vast [1]-[10]. Rahman et. al. [2] proposed the concept of incremental inductance which is measured on successive PWM (pulse width modulation) periods, although position estimation could not be extended to the full plunger travel. An improved method is presented in [1] considering the effect of supply variations and load forces. In [3] the current waveform is considered as an amplitude modulated signal and position information is extracted from average current and ripple, latter caused by the PWM excitation. By taking a simple series RL (resistance-inductor) model the current response is approximated by exponential functions in [4], where the real part of the impedance is assumed to be position dependent due to eddy current intensity. After all, position is associated with

current ripple that is measured at the beginning and at the end of each PWM impulse. A different approach was introduced in [5], [6] by injecting a sinusoidal scan voltage and measuring phase shift [5] or current amplitude [6]. Wu et. al. [5] connected an external capacitor in series to the solenoid which formed a resonant RLC circuit. A sinusoidal excitation voltage was applied close to the resonance frequency, at which the phase shift of coil current is highly sensitive to inductance variations. This self-sensing scheme was applied to a dual, push-pull solenoid where one coil was actuating and the other was sensing respectively. In [6] the valve is driven by an H-bridge and the damping effect on the current amplitude of an RLC circuit is exploited. Compared to [5], the winding’s stray capacitance is used instead of an external capacitor to form the resonant circuit, and the system is excited at its “internal” resonance. In [9] a method, based on measuring the back EMF (electromotive force) which is generated by the electromagnetic actuator, is described to determine the plunger position. Major limitations of [9] occur at no or slight plunger motion where the EMF is difficult to be accurately measured or nil. In addition, the required plunger oscillation might be undesirable in certain applications e.g. flow control or on-off applications. More complex methods are also proposed by Eyabi et. al. [7], introducing a detailed valve model and using a sliding mode based sensorless control strategy to reduce the seating velocity of such devices. However, the sliding mode concept uses a non constant switching frequency, which might cause undesirable EMC (electromagnetic compatibility) issues. In addition, complex models require more computational effort which is not preferred in embedded applications. Yuan et. al. [8] published a flux linkage observer for push-pull solenoids to estimate the inductance and position of the device. With the help of auxiliary coils attached to the main windings of the actuator, an attempt is presented in [10] to determine the position through flux linkage reconstruction.

Under certain working conditions varying external forces might be present on the solenoid’s plunger, e.g. formulated from fluid pressure (Fig. 1). In the majority of technical literature the effect of an externally applied load and its compensation in the sensorless principle of solenoids is still an open issue. Also no experimental test results are presented on the load disturbance rejection of the proposed methods. In [2] external forces are considered to be difficult to predict and model, thus omitted. However, [2], [3], [4] recorded the set of

inductance and current ripple values at fixed plunger positions and average currents. From these data load compensation might be possible, although information about its magnitude is lost. Measurements were also carried out at fixed plunger positions in [7] but with the sliding mode concept considerable parameter insensitivity is ensured. Yet robustness, tracking error, etc. are not tested in case of sudden and significant changes of mechanical inertia for [7], [8], [10], nor the problem of external forces on position estimation is discussed in [5], [6]. On the other hand, [9] achieved and presented results on combined position and force estimation by exploiting the plunger motion generated back EMF. Yet, this principle has strong limitations as the plunger must not be stationary. However, a method and corresponding experimental results are presented in [1] which was able to overcome force disturbances, although only at given load levels.

In this paper a method is proposed to estimate the position of the spool in solenoids, capable of compensating and thus, estimating load forces as well. A sinusoidal scan signal is employed and a model is derived from experimental analyses. The necessary hardware is simple; therefore, the developed method is suitable for cost effective, embedded systems. Other major phenomena, e.g. the effect of scan frequency and supply voltage, are also studied.

Despite temperature being an important input quantity, thermal analyses are not in the scope of this paper. This effect is neither dealt with in the listed literature. Regarding the presented measurement results, those were captured at the same ambient (room) and valve operating temperature.

#### A. Operation of a Solenoid Actuator

The literature dealing with the modeling of solenoid actuators is vast e.g. [2], [7], [11]-[13]. A picture of a solenoid, used for flow control purposes, is given in Fig. 1. From an operational viewpoint current builds up in the winding due to the terminal voltage (usually from PWM). Through the air gap a magnetic force, which is related to the coil current, is exerted. This magnetic force and external forces (e.g. fluid pressure) immerse the plunger into the housing, thus, the outflow orifice can be altered. These forces are counteracted by the valve return spring and cancel each other in steady state.

A solenoid actuator's major input parameters are the voltage, external load, and temperature. Strictly speaking its output quantity is hydraulic resistance (outflow orifice); however, in case of relays or force actuators (free plunger, no orifice) the hydraulic side does not exist. Besides, it is the position of the spool which determines the intake and outlet areas through only geometric constraints. Therefore; the corresponding literature [1]-[14] agrees on spool position being the characteristic output quantity of a solenoid actuator.

In the following, a specific pull type solenoid was studied and all presented results are related to it. Plunger position is taken such that it increases with the plunger being more immersed into the housing.

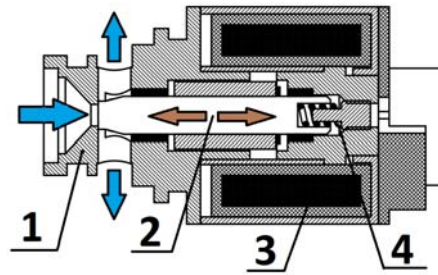

Figure 1. Schematic of a solenoid actuator (flow control purposes) [14]: 1- orifice, 2 - spool, 3 - coil, 4 - return spring.

#### B. The Experimental Setup

In order to analyze and measure the given solenoid actuator a dedicated measuring and testing environment has been built that is illustrated in Fig. 2. A detailed description of the experimental setup is provided in [14] but the main features are briefly discussed.

Into a specific mechanical device which is presented in Fig. 2 the tested solenoid is mounted. The layout is arranged in a vertical configuration to reduce subsidiary friction, and the external load is provided by the gravitational force of reference masses. In steady state, this force is constant regardless of the plunger position. Position measurement is realized by reflective optical sensors, the concept being also illustrated in Fig. 2. These devices host a light source (diode) and photo detector (transistor) in parallel, operated at the infrared region. Since the amount of light arriving to the photo transistor is determined by the distance of the reflective medium (circular disc), thus reflected photo current, position information is extracted from the emitter current. As illustrated in Fig. 2, the reflective disc is attached to the spool, thus the spool's motion and its position is captured.

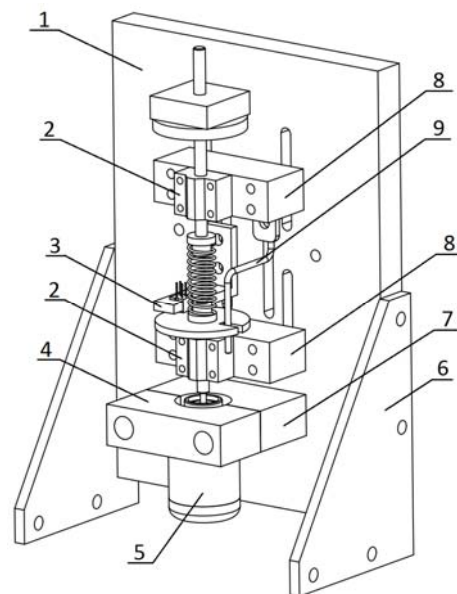

Figure 2. 3D model of the measuring bench [14]: 2 - linear bearing, 3 - reflective optical sensor, 5 - solenoid valve.

For producing the necessary PWM waveform and acquiring the electrical and mechanical signals (e.g. current, position) of the solenoid, a dedicated HW has been built hosting a 16 bit DSP (digital signal processor) (dsPIC33FJ128GP from Microchip). From a LabVIEW based PC (personal computer) interface the DSP can be accessed, from which the sampled data is transferred to LabVIEW for further high level signal processing. Any measurement parameter e.g. PWM and sampling frequency can also be set through LabVIEW. Sampling, however, is performed by the microcontroller's internal 12 bit ADC (analog to digital converter) capable of 470 kSPS (kilo sample per second). With the DSP board any arbitrary PWM waveforms can be generated and future estimation methods or controllers be directly studied in an embedded environment.

## II. POSITION ESTIMATION IN THE SOLENOID ACTUATOR

The sensorless principle is usually based on measuring electrical signals (current, voltage) from which information about e.g. plunger position is extracted. Considering the aforementioned estimation methods, mainly two categories can be distinguished. From one point one can rely on observing and tracking global parameters such as flux linkage [7], [8], although initial conditions and integration error may yield some problem. Alternatively, a scan signal can be superposed onto the drive signal thus exciting the system "locally" [1]-[6], and measuring its local properties, e.g. inductance or impedance. However, these local states might overlap [1], thereby making estimation more difficult. In this paper, the latter process is preferred and a method similar to [5], [6] is presented.

### A. The Proposed Method

In [5], [6] the idea is to excite the system with a sine close to the resonance frequency and measure either phase shift or attenuation. Auxiliary hardware is necessary, and implemented for scan signal generation and signal reconstruction. We use a considerably simpler hardware layout, illustrated in Fig. 3, to realize scan signal generation and signal reconstruction. The solenoid is driven by PWM in a low-side single switch configuration. During PWM on periods the supply voltage is applied to the solenoid and current flows through the switch and during off periods the coil current flows through the freewheeling diode. The coil current is measured on a high side shunt resistor  $R_s$  by a common mode differential amplifier.

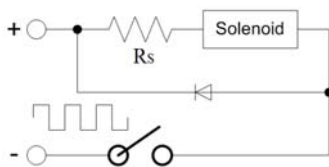

Figure 3. Hardware concept of the proposed method.

The proposed concept, which utilizes the hardware in Fig. 3, is the following: using the single switch (unipolar), low-side drive configuration, a sinusoidal component is added to the base duty ratio of the PWM (1). The necessary signals to be measured are coil current and supply voltage.

$$Dr(t) = ZOH \left[ D_0(t) + d(t) \cdot \left( 1 + \sin \left( \frac{2 \cdot \pi \cdot f_{scan} \cdot t}{F_{PWM}} \right) \right) \right] \quad (1)$$

Since duty ratio cannot change until the end of its pulse period, the actual sine is fed through a ZOH (zero order hold) unit, introducing some additional phase lag. That is, at the beginning of a new PWM cycle the corresponding duty ratio is the base duty ratio plus the value of the sine wave at the beginning. This way of signal generation can be readily implemented in embedded applications. The offset by "1" is necessary to avoid negative duty ratios. Also, the term  $D_0$  corresponds to the base duty ratio, as the valve has to be actuating as well. The sine wave is generated using a dedicated LUT (look up table). Regarding the scan frequency, it is chosen to be significantly lower than the switching frequency. Fig. 4 illustrates such a waveform and its corresponding PWM output, where the ZOH effect is quite clear. Fig. 5 shows the FFT (Fast Fourier Transform) of both duty ratio and PWM output, with the sinusoidal part also visible at the first bin. In fact, its amplitude is proportional to the amplitude of duty ratio and supply voltage. Since the frequency of the sinusoidal part is exactly known; valve parameters (impedance) are to be measured and determined only at the scan frequency, thereby a full FFT computation is not necessary. It has to be noted that the criteria of coherent sampling must be met to obtain a good frequency estimate and sampling frequency must be high enough to minimize anti aliasing due to the rectangular switching waveform, although the electrical subsystem of the valve behaves as a low pass filter. Sampling is internally generated by the DSP and triggered when the LUT turns over.

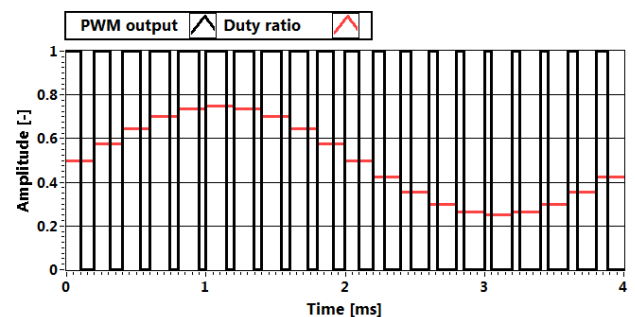

Figure 4. The duty ratio and corresponding PWM output.

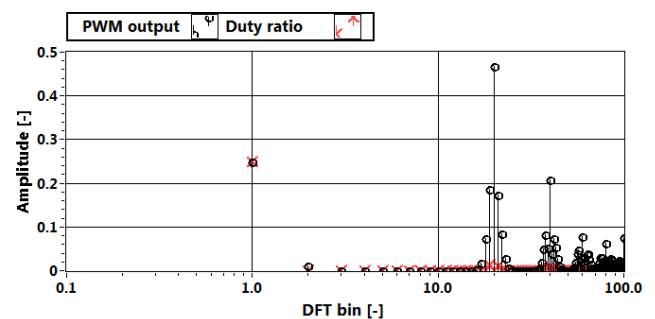

Figure 5. FFT of the duty ratio and PWM output.

Compared to [5], our method uses a far simpler hardware configuration. Instead of a sinusoidal voltage source, excitation is created by chopping a DC one i.e. a battery in a sinusoidal way. Additionally, the external capacitor and other dedicated phase detecting circuitry are omitted and the same coil is used for actuating and sensing purposes. In [6] a DC source is used and the valve is driven by an H bridge consisting of four switches and additional drive circuits. The valve is excited at its internal resonance frequency and the sum of the squared current difference between the signal and average current is linked to position. Instead, we use a single switch unipolar layout and we compute an FFT (coherent sampling) at the scan frequency to evaluate current amplitude and phase shift. The FFT is also a robust estimation. Major drawback of the proposed method is its possibly lower estimation bandwidth as the estimation speed equals the scan frequency which is significantly less compared to [1], where position data can be produced in every PWM cycle.

In the proposed method, mainly three effects determine the uncertainty of estimation. First, jittering during the trigger period might introduce an error in the phase of the FFT vector. However, sampling is synchronized internally by the DSP; therefore, it is almost zero or a constant offset. Secondly, if a significant ambient noise is present in the sampled current waveform some error term might be injected into the corresponding FFT bin. In case the length of FFT increases, the “constant” noise power spreads through a wider spectrum, thus enhancing SNR (signal to noise ratio). During the experimental analyses a 1024 point FFT was calculated. Last, data is sampled by the internal 12 bit ADC of the DSP device, which inevitably introduces some quantization error, thus, noise associated with it. If the error is uncorrelated with the input signal, the quantization error has a uniform distribution in the  $[-\text{LSB}/2; \text{LSB}/2]$  interval, where LSB stands for least significant bit. If assuming a white noise, (2) gives a good approximation for its power. This uncertainty can be imagined as the signal’s FFT vector with a circle attached to its tip with variance (2). In our case the SNR associated to quantization, in terms of power, is found to be at least 50 dB, thus it is insignificant.

$$P_{\text{quantization}} = \frac{\text{LSB}^2}{12} \quad (2)$$

### III. EXPERIMENTAL ANALYSES

An experimental model of a valve actuator is established by applying the proposed sinusoidal scan signal. Because the frequency of the scan signal and the magnitude of supply voltage are known, an equivalent electrical impedance (R-L model) is derived at the scan frequency. This impedance, and other relevant quantities e.g. average coil current, are recorded at various spool positions. We also study the effects of supply voltage, scan signal frequency and external load on the electrical impedance of the solenoid.

Regarding further measurement processes the duty ratio of drive PWM was swept forwardly and then reversely, thus recording full cycles of current and inductance curves as the function of plunger position. From the LabVIEW interface the necessary measurement parameters are sent to the custom HW,

which sets the PWM and samples the signals then transmits the raw measurement (ADC) data back to PC, where it is evaluated. On the different directions (reverse, forward), polynomial approximation was performed and a much densely interpolated (128 points) curve was stored in a LUT (Lookup table) for further estimation algorithms.

#### A. Effect of Scan Frequency

This section is dedicated to study the valve’s behavior under different scan frequencies, as it is expected to greatly influence the measured electrical impedance. Besides, it also limits the speed of future position estimation. Regarding the necessary coil current, it is not expected to significantly vary with frequency due to reasons explained in [1]. The measured inductance, however, is expected to increase with a smaller frequency as secondary magnetic phenomena, such as eddy current intensity become less significant. Measurement results are presented in Figs. 6-9 at a constant supply voltage of 12 V and 0 N external load. The measured current and inductance values; at different frequencies are plotted in Figs. 8-9; and at different modulation amplitudes are plotted in Figs. 6-7. The “pp” symbol in the figures refers to peak to peak percent in duty ratio, which is twice the amplitude of the sine. Thus, 0.1pp refers to a sinusoidal component which has the amplitude of 5%. The switching frequency was 5 kHz.

We can conclude that as expected, the necessary average coil current is the same irrespective of scan frequency and modulation amplitude because coil current is a “global” quantity of the system [1]. However, the inductance in Figs. 7 and 9 show significant variations as expected [1]. We can also observe that, with increasing modulation amplitude the drop in inductance (valley) at small spool positions becomes more and more significant. This effect can be denoted to the back EMF of the solenoid, that is the magnitude of excitation at the given frequency becomes large enough for the spool to oscillate, thus EMF is generated. The higher the frequency, the larger the modulation amplitude has to be for EMF because the electrical and mechanical subsystems act as low pass filters. Apart from the effect of EMF, inductance varies slightly with modulation amplitude in Fig.7, but at higher frequency it diminishes due to secondary magnetic phenomena e.g. eddy current intensity.

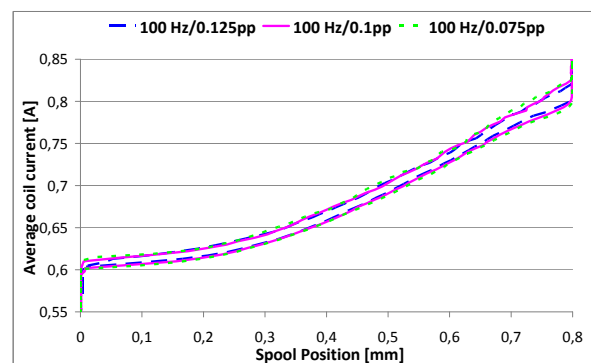

Figure 6. Average coil current as the function of modulation amplitude.

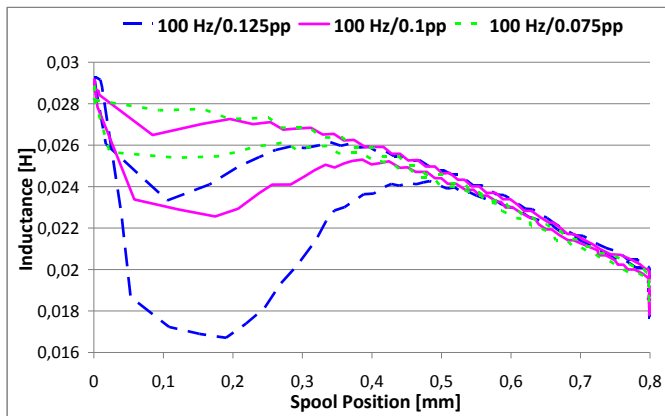

Figure 7. Inductance at different modulation amplitudes.

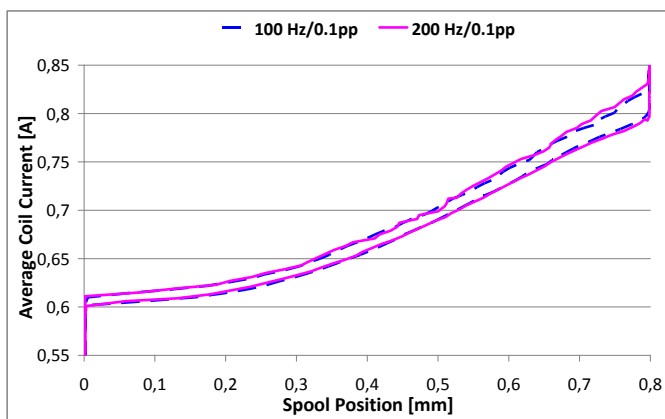

Figure 8. Average coil current at different scan frequencies.

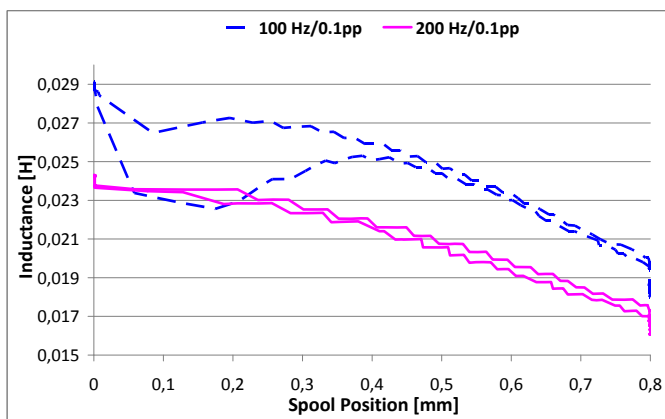

Figure 9. Inductance at different scan frequencies.

### B. Effect of Supply Voltage

During the PWM “on” period, the solenoid valve is subject to the full supply voltage which can vary significantly in battery powered applications. Since secondary magnetic phenomena, such as eddy current intensity is partly related to the speed of flux change, the behavior of the valve is expected to somehow depend on the chopped voltage level. Therefore,

the effect of supply voltage was also investigated. At a zero load condition, and at 5 kHz switching and 83.33 Hz scan frequencies, different supply voltages were applied. The duty ratio’s sinusoidal part was adjusted such that the scan voltage amplitude remained constant, thus, the amplitude of the excitation (scan) signal was the same. With average coil current being a global parameter of the system, it is not expected to vary with the different supply voltage levels compared to inductance.

Experimental analyses in Figs. 10-11 indicate the previous assumptions to be correct. According to Fig. 10 coil current almost remains the same but inductance in Fig. 11 slightly increases with supply voltage. The effect of EMF is clearly visible therefore modulation amplitude is to be further reduced.

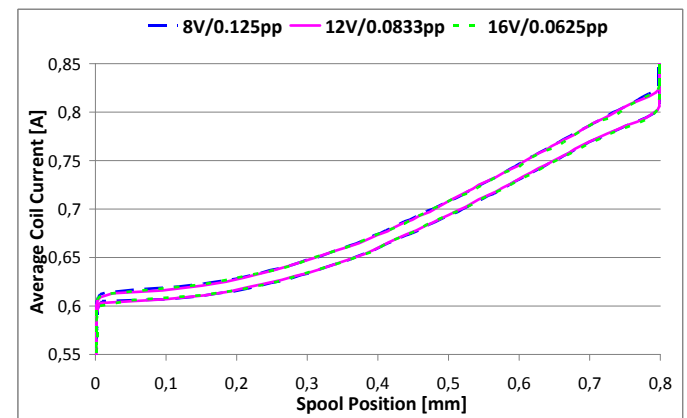

Figure 10. Average coil current at different supply voltages.

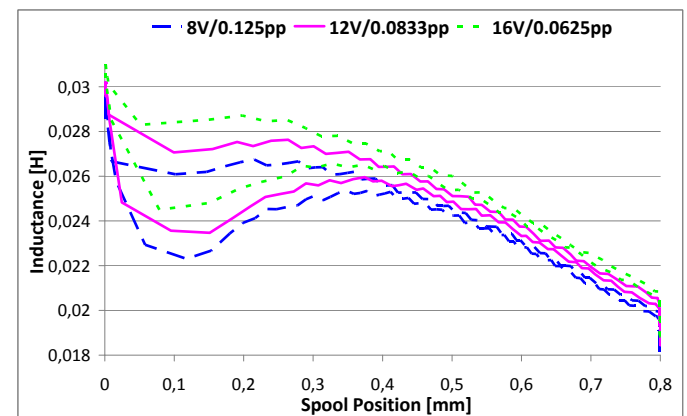

Figure 11. Inductance at different supply voltages.

### C. Effect of External Forces

In certain applications the solenoid valve is subject to varying load excitations e.g. fluid pressure in flow control. For a complete analysis, this effect has to be considered because the necessary magnetic force, thus coil current and inductance, to reach the same spool position changes if a different external load is applied. In the following analyses coil current and inductance curves were recorded at different external forces but at a constant 12V supply voltage, 5 kHz switching frequency,

83.33 Hz modulation frequency and 5% peak to peak sinusoidal component in the duty ratio, thus EMF becomes negligible. The results are plotted in Figs. 12-13 and they match the expectations, that is the coil current and inductance greatly depends on the magnitude of external load and with larger force less current is needed to reach the same position. Some hysteresis is also observable and inductance increases.

A rather strange phenomena, however, is the reversal of  $L$  (inductance) curves, namely it decreases after a certain position despite being more immersed into the housing. Concerning further estimation methods, this non monotonic behavior causes difficulties, as multiple position values are linked to the same inductance. This problem and its solution are better discussed in the next chapter IV. From one hand the aforementioned behavior can be denoted to secondary magnetic nonlinearities (e.g. saturation, nonlinear magnetization curve [2], [11], [13]), namely that  $L(x, i)$  is also current dependent. That is, the inductance which is related to permeability, that is the slope of the magnetizing curve, reduces after a specific current density despite spool position. The eddy current phenomenon also contributes to this effect [4], the flux lines are more repelled with the plunger being more immersed into the housing. The empirical inductance data recorded in Fig. 13, apart from the effect of EMF, shows a highly similar shape and behavior to results presented in [11], obtained from FMEA model and simulation.

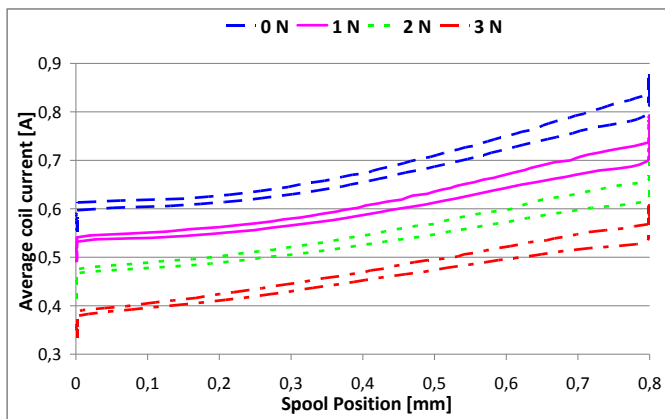

Figure 12. Average coil current at different external forces.

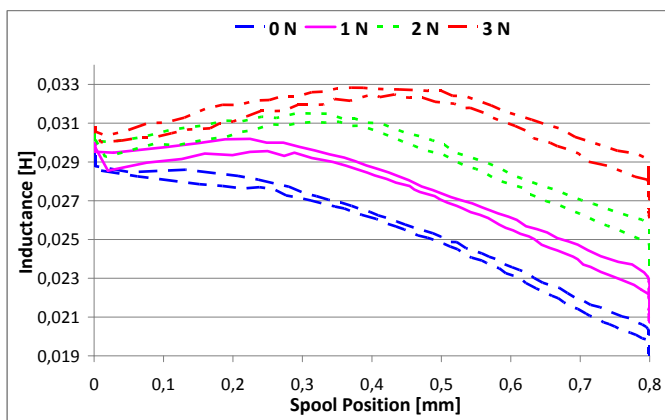

Figure 13. Inductance at different external loads.

#### IV. LOAD COMPENSATION AND ESTIMATION

In this paper, two parameters of a solenoid actuator are to be estimated, namely plunger position and external load. The presented estimation procedure is similar to that in [1]. According to Figs. 12-13 proper load compensation is not possible by monitoring a single parameter, due to different positions related to the same inductance or current in case of load changes. For this reason at least two independent parameters are needed, linked to force and position respectively. Regarding plunger position, it seems reasonable to associate it with the inductance due to the position dependent air gap (magnetic reluctance), however, it also depends on current. On the other hand, the (average) coil (magnetizing) current determines the magnetic force exerted onto the plunger, thus it could also provide information about its magnitude. Yet, magnetic force is also a function of position since less current is needed to produce the same force provided a smaller gap (higher reluctance). The steady state force equation is given in (3), where  $F_{spring}$  represents the position dependent return spring force,  $F_{magnetic}$  the position and current dependent pulling magnetic force and  $F_{external}$  the applied force from e.g. pressure. At equilibrium position the return spring compensates the pulling magnetic force plus all external disturbances.

$$F_{spring}(x) = F_{magnetic}(i, x) + F_{external} \quad (3)$$

In the previous chapter III.C, a major problem has been already pointed out. Compared to the coil current curves (Fig. 12), which are strictly monotonic, inductance (Fig. 13) takes same values at multiple positions. Regarding the estimation concept, only current and inductance data are available, based on which the inverse of the captured transfer function has to be performed. This can be imagined as drawing a horizontal line from the measured values and taking those positions where it intersects the recorded curve. With the help of the monotonic coil current; however, the above position overlapping can be resolved, because different currents belong to those positions that yield the same inductance. Therefore only that position is the "valid" one from the multiple choices which is the best related to the measured current.

In the above reasoning the external load was assumed to be constant, thus it was a local decision problem. Now we introduce the general process. The magnitude of external load and plunger position are estimated using the previously described  $(L, i)$  pair, and the same process is carried out as in [1]. The following description can be also found in [1]. From the interpolated position versus current and inductance curves, which were obtained at different loads (Fig. 12-13), a main LUT is formulated that handles the forward and reverse directions separately due to hysteresis. Let us assume that the plunger is at position  $d$  and force  $F$  is applied. If all  $L, i$  pairs are taken at  $d$  from the main LUT, there will be only a single pair being mutually the closest to the calculated  $L$  and  $i$  values respectively, at  $F$ . In our case  $d$  and  $F$  are unknown but  $L, i$  available. Regarding the search algorithm, only data at specific force levels are available (main LUT); therefore, the estimated force also takes given values. Strictly speaking, this is not an

estimation, but decision making problem. The method is the following:

- The inductance and average current curves are organized by a given set of external force in the LUT. At each force level the plunger positions, related to the calculated average coil current and inductance, are retrieved separately.
- At all force levels, there is a position estimated from coil current and another (or multiple) from inductance. The absolute difference of these two positions is taken and a minimum is to be found along the force, see Fig. 14. However, there might be multiple position values related to inductance at the same force (Fig. 13); therefore the above process is locally performed. For this issue refer to the second paragraph of this chapter.
- The force, at which the difference takes its minimum, will be the chosen force. Notice in Fig. 12 and Fig. 13 that at the “real” force the (L, i) pair must give the same position. At all different load levels, however, these will significantly differ.
- In case the force is found, the chosen position will be the one derived from average current, since it is less noisy.
- Hysteresis is taken into account by monitoring the change in average coil current, and the corresponding curves are used for decision making.
- Data are stored at only specific force levels, therefore it is not strictly an estimation, but rather a decision making problem with a force quantizer. However, interpolation is possible but it is not in the scope of present study.

	$F_1$	$F_2$	$F_3$	.....	$F_N$
<b>d* from “i”</b>	$x_1$	$x_2$	$x_3$	.....	$x_N$
<b>d* from “L”</b>	$y_1$	$y_2$	$y_3$	.....	$y_N$
<b>difference</b>	$ x_1 - y_1 $	$ x_2 - y_2 $	$ x_3 - y_3 $	.....	$ x_N - y_N $

Figure 14. Calculation process for load and position estimation.

## V. EXPERIMENTAL RESULTS AND COMPARISON

The usability of the proposed methods was verified by a set of measurements in an open loop configuration. Data was collected by the custom HW and sent back to LabVIEW which evaluated the results and performed the position and force estimation (decision). During the analyses such external forces were chosen that interpolation in force was not necessary, namely it coincided with one of the exciting forces in Fig. 12. For this reason, output force is “quantized”, namely only such values can be returned which are defined in the main LUT. In case a different force is applied, the decision process rounds it up and gives the closest match. However, interpolation could be implemented but it required a better identified transfer function, and it is not in the scope of present study. The supply voltage was held constant at 12 V and the scan parameters were

the same as in Section III.C (5 kHz, 83.33 Hz, 0.05pp, 85.33 kHz sampling).

Data concerning the “static” external force estimation is presented in Fig. 16. The duty ratio was held constant and from a zero force condition the magnitude of external load was consequently altered to 0.5N, 0N, 1N, 1.5N, 1N, and back to 0N. The developed method indicates a good external force rejection in position estimation with adequate position and load measurement properties; although, there are a few dips and spikes in force and position. This error can be denoted to the quantization of output force and measurement noise. Given a noisy input signal, if its variance is high enough, there is a chance that the algorithm makes a false decision in force and position, jumping to adjacent levels. Since force is decided first and position is associated with it afterwards, position error in Fig. 15 and 16 is high in case of false decisions due to the rough force resolution in the main LUT.

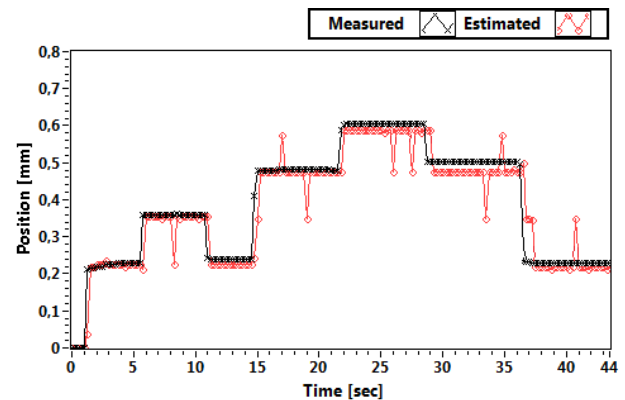

Figure 15. Open loop position estimation.

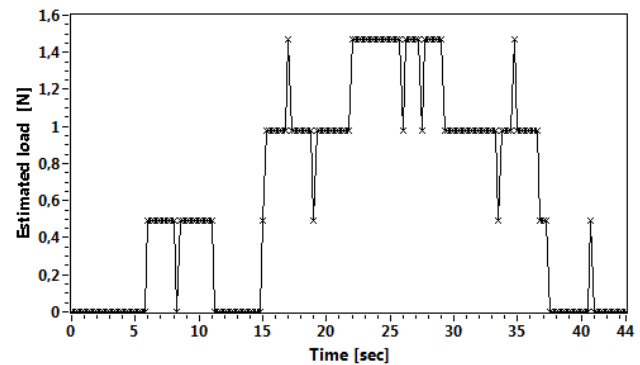

Figure 16. Estimation results for external load, open loop.

## CONCLUSION

In this paper a method has been developed to estimate the position of the moving part in a solenoid actuator. The concept of applying a sinusoidal scan signal, which was superposed onto the main drive signal, was employed to identify and measure the studied actuator while satisfying the original actuating purposes. The developed method used PWM and

required a very simple hardware configuration, thereby it became suitable for cost effective embedded applications. A detailed experimental analysis of a solenoid actuator has been performed as well and the effects of supply variations, external forces and scan signal on the solenoid's behavior (model) were investigated and reported. From the experimental results a model of the actuator was derived and a method to estimate position, while compensating force disturbances, was presented. Thus, estimation of load forces could be also realized which may extend the use of such devices and may further improve cost effectiveness. Experimental results were also provided and indicated that the presented method performs acceptable position and force estimation, although force estimation was restricted only to certain force levels.

#### REFERENCES

- [1] I. Dülk, T. Kováčsházy, "Sensorless position estimation in solenoid actuators with load compensation", Proceedings of IEEE I2MTC 2012 Conference, ISBN: 978-1-4577-1771-0, pp. 268-273, 2012 may 13-16, Graz.
- [2] M. Rahman, N. Cheung, K. W. Lim, „Position estimation in solenoid actuators“, in Industry Applications, IEEE Transactions on, vol. 32, no. , pp. 552-559, 1996.
- [3] Jyh-Chyang RENN, Yen-Sheng CHOU, "Sensorless Plunger Position Control for a Switching Solenoid", JSME International Journal, Series C, Vol. 47, No. 2, pp. 637-645, 2004.
- [4] Dieter Pawelczak, Hans-Rolf Tränkler, "Sensorless Position Control of Electromagnetic Linear Actuator", IMTC 2004 – Instrumentation and Measurement Technology Conference, pp. 372-376, 2004.
- [5] Shang-The Wu, Wei-Nian Chen, "Self-sensing of a solenoid valve via phase detection", 2009 IEEE/ASME International Conference on Advanced Intelligent Mechatronics, Suntec Convention and Exhibition Center, Singapore, July 14-17, 2009.
- [6] Maridor, J., Katic, N., Perriard, Y., Ladas, D., "Sensorless position detection of a linear actuator using the resonance frequency", Electrical Machines and Systems, ICEMS International Conference, 15-18 Nov. 2009, Print ISBN: 978-1-4244-5177-7.
- [7] Peter Eyabi, Gregory Washington, "Modeling and sensorless control of an electromagnetic valve actuator", Mechatronics 16, pp. 159-175, 2006.
- [8] QingHui Yuan, Perry Y. Li, "Self-Sensing Actuators in Electrohydraulic Valves", ASME International Mechanical Engineering Congress and Exposition, IMECE2004-62104 pp. 129-135, 2004.
- [9] Ben Hanson, Martin Levesley, "Self-sensing applications for electromagnetic actuators", Sensors and Actuators A: Physical, vol. 116, pp. 345-351, 2004.
- [10] Marcello Montanari, Fabio Ronchi, Carlo Rossi, Alberto Tonielli, "Control of a Camless Engine Electromechanical Actuator: Position Reconstruction and Dynamic Performance Analysis", IEEE Transactions on Industrial Electronics, vol. 51 no. 2, pp. 299-311, 2004.
- [11] Song-Min Wang, Takashi Miyano, Mont Hubbard, "Electromagnetic Field Analysis and Dynamic Simulation of a Two-Valve Solenoid Actuator", IEEE Transactions on Magnetics, vol. 29 no. 2, pp. 1741-1746, 1993.
- [12] So-Nam Yun, Young-Bog Ham and Jung-Ho Park, „Characteristics Analysis of a High-Pressure Relief Valve for the Common Rail System“, Fluid Power and Mechatronics (FPM), Beijing, pp. 248-252, 2011.
- [13] Joe Y. Xiang, "Modeling and Control of a Linear Electro-Mechanical Actuator (LEMA) for Operating Engine Valves", IEEE Industrial Applications Conference, vol. 3, pp. 1943-1949, 2002.
- [14] I. Dülk, T. Kováčsházy, "A Novel Experimental Setup for Solenoid Actuators", IEEE IECON 2013 conference, Vienna, November 10-13, accepted for publication.